



Linea LEN

EN54-24-certified line source speakers for voice alarm applications.

User Manual

LEN-20 (b)

LEN-60 (b)

LEN-100 (b)

LEN-150 (b)

LEN-220 (b)

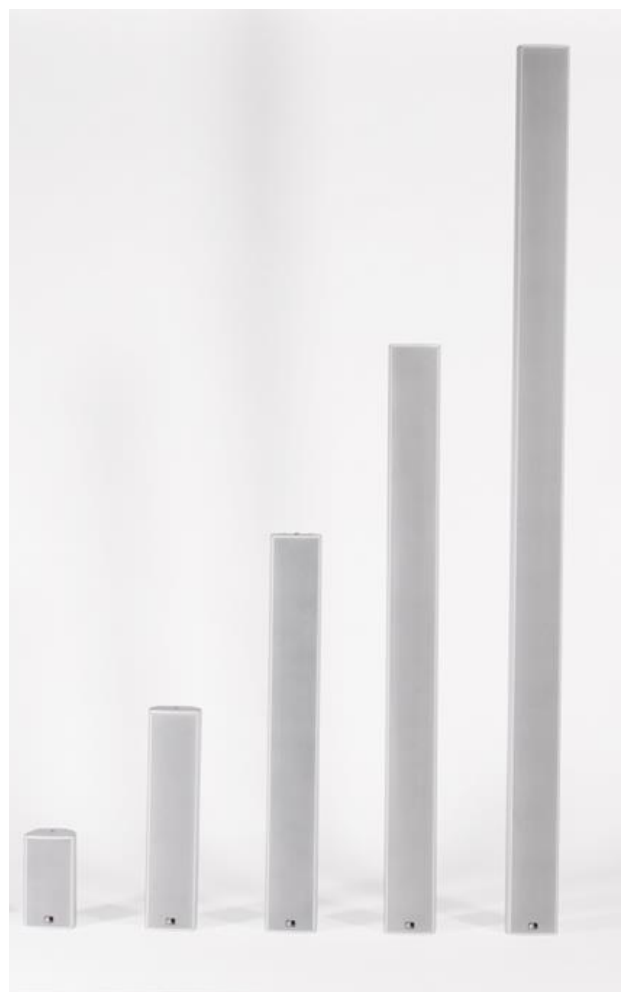

Please read this manual carefully before operating the equipment and keep it for the future reference.

Content

- 1. Important safety information..... 3
 - 1.1 Connections and cabling 4
- 2. Introduction..... 5
 - 2.1 Intended readers of this manual 5
 - 2.2 Scope of supply..... 5
 - 2.3 Unpacking the product..... 5
- 3. Setup and operation..... 6
 - 3.1 Installation and mounting 6
 - 3.2 Wiring 7
 - 3.3 Operating conditions..... 8
 - 3.4 Transportation and storage..... 8
 - 3.5 Maintenance..... 8
 - 3.6 Servicing and Repair 8
- 4. Technical data..... 9
 - 4.1 Measuring Charts 10
 - 4.2 Reference Axis Plan 12
- 5. Accessories 13
- 6. EG Conformity (CE marking)..... 14
- 7. Declaration of Performance 15
- 8. WEEE Directives (Disposal)..... 16
- 9. Certificates..... 16
- 10. Appendix..... 17

1. Important safety information

Please read the following safety information carefully before using the system. This information should be kept handy for future reference. Reading this manual does not replace the need for awareness and observation of all current local safety regulations, legal requirements and compliance with safe working methods at the venue.

The following information and technical specifications have been based on data that was available at the time of publication. We expressly reserve the right to make changes as necessary.

Markings and definitions

Danger

This term is used to denote high-risk hazards which, if not prevented, can result in death or serious injury.

Warning

This term is used to denote medium-risk hazards which, if not prevented, can result in death or serious injury.

Caution

This term is used to denote low-risk hazards which, if not prevented, can result in minor or moderate injury.

Danger

To avoid risk of injury or death, please make sure that anyone involved in installing, operating or dismantling the system has read this user manual.

Warning

To prevent any potential injury caused by the system falling down,

- it must be firmly fixed to building structures according to the mounting instructions. Please also ensure that these structures combined with the equipment used for system deployment have sufficient load-bearing capability and are structurally suitable.
- Only use the recommended **Fohhn** accessories with this product, or other components that have been explicitly specified in this manual.
- it must be regularly checked for any signs of wear or loosened parts on load bearing connections.

To minimize the risk of fire or electric shock,

- the system should not be opened: It does not contain any parts to be maintained by the user. For maintenance requirements, please consult a qualified technician.
- items that have a naked flame (such as candles) should not be placed near the system.

To avoid injury, this product must be taken out of operation, appropriately marked and secured against unauthorised use if

- it shows any visible signs of damage.
- there is any indication of loose parts.
- it does not work properly.
- it has been subjected to poor transportation conditions (e.g. with unsuitable packaging).

To avoid injury

- this product must not be stored, installed or operated in reach of children.

To prevent hearing damage caused by excessive sound pressure levels, do not

- stand directly in front of a loudspeaker, that is ready for operation, without wearing ear protection.
- subject yourself to high sound pressure levels over a long time period.



Caution

To prevent damage to the product, please avoid the following:

- acoustic feedback
- high powered, permanently distorted signals

1.1 Connections and cabling

Cables form the vital links between the different components in an audio system.

Please make sure that your cables are in perfect working order. Only use branded cables of an appropriate cross section!

Speaker cables must be laid and secured in a way that they cannot be harmed by tools or jammed and damaged by the loudspeaker or wall brackets.

Wiring of loudspeaker must be solely executed by skilled personnel. We recommend using ferrules for stranded wires.

Avoid excessive torque to the terminal screws!

2. Introduction

Congratulations on purchasing a Fohhn LEN loudspeaker system. LEN loudspeakers are passive, weatherproof 100V systems with aluminum housing, specially designed for use with voice alarm systems and certified according to EN54-24, Type B. Thus, they are equally suited to indoor or outdoor use.

LEN loudspeaker systems feature two-way technology with integrated passive filters that guarantee an even dispersion and the best possible coverage. An integrated Fohhn Source Division Waveguide (SDW) effectively suppresses side lobes, resulting in improved speech intelligibility for acoustically challenging venues with long reverberation times, such as railway stations, airports, auditoria and conference halls.

2.1 Intended readers of this manual

This user manual outlines the operation and potential applications of the Linea LEN loudspeaker. The information is aimed at system technicians, users and anyone else involved in setting up, operating and dismantling the system.

2.2 Scope of supply

All Fohhn products are developed by qualified engineers. During the build process, current safety regulations are always kept in mind. Each product is thoroughly tested before leaving the factory.

Please examine your new product carefully for any signs of damage that may have occurred during transportation and, if necessary, inform your dealer and the transport company immediately. Please also check that the packaging includes all components belonging to the product. If anything is missing, please let your Fohhn dealer know immediately.

Your Linea LEN system contains the following components:

- 1 x LEN-20/60/100/150/220 (b)
- 1 x quick start guide
- 1 x cover plate (including 2 x cable glands & dummy plugs)

2.3 Unpacking the product

When unpacking the system, we recommend proceeding as follows:

1. Open the packaging and take out the product.
2. Check the product carefully for any signs of damage during transportation. If any is found, please notify the transport company immediately. Re-compense for damage during transportation can only be claimed by the consignee i.e. you. Please retain all packaging for examination by the transport company.
3. The packaging should ideally be kept in any case, as products should never be returned without their original packaging.

3. Setup and operation

3.1 Installation and mounting

Depending on the particular model, LEN (b) loudspeakers can be mounted on building structures using the following wall brackets (see chapter 5. Accessories): WS-2, WS-4, WS-5, WLX-100, WLX-200

When mounting a wall bracket, please refer to the information given in its dedicated manual.

- ⚠ Loudspeaker mounting within buildings should only be carried out by trained personnel.
- ⚠ Please ensure that the wall brackets you have selected are suitable for use with the product to be installed.
- ⚠ We recommend that you read Chapters 1 and 2 of this user manual carefully.
- ⚠ You must also observe any relevant national safety requirements.

Connection to building structures

- ⚠ Make sure that the building structure to which the loudspeaker will be connected is statically suitable.
- ⚠ Surfaces that support brackets must be sufficiently stable and not be subject to long-term settlement.
- ⚠ Wall plug and screw connections must be of sufficient size to cope with the tensile strength required. This will also depend on the type and inclination of the particular speaker mounting.
- ⚠ If you are uncertain about any of the above points, it is imperative to consult a qualified structural engineer.

Connections between loudspeakers and brackets

All LEN (b) loudspeakers are equipped with slot nuts placed in the rear T-slot at delivery. All Fohhn brackets include fastening materials for connecting them to the loudspeaker.

- ⚠ If you want to use other screws, their strength must be at least class 8.8; this corresponds to a tensile strength of 800 N/mm² and a 0.2 % proof stress of 640 N/mm².
- ⚠ Never use screws that are longer than the originals supplied. This could damage structures inside the loudspeaker or cause a short circuit.
- ⚠ When connecting the following brackets to LEN-series loudspeakers, a tightening torque of 10 Nm is required: WS-2, WS-4, WS-5, WLX-100, WLX-220. This applies to standardised screws without washers: DIN912/6912, DIN931/933, ISO7380.

Safety

Regardless of any currently applicable legal requirements, we strongly recommend securing all systems to a second separate point (secondary safety).

- ⚠ When applying a secondary safety to a LEN (b) loudspeaker only Fohhn safety brackets SB-S und SB-L must be used. The maximum load of the safety brackets must never be exceeded.
- ⚠ To secure the loudspeaker, only suitably sized permitted elements (such as wire ropes, shackles or quick links) should be used. The maximum falling distance, before the safety element is engaged, should be as small as possible and must not exceed 200 mm.

⚠ When anchoring the system to the wall, dynamic strength caused by the falling loudspeaker must also be considered.

3.2 Wiring

All loudspeakers of the LEN (b) series are passive systems designed for use with external amplifiers. Two terminal connectors are used for wiring, each with two pins and supplied at delivery. They are suitable for wires with a cross section of up to 2,5 mm². All cables used must be of an appropriate cross section.

For models with a built-in 100 V/70 V transformer, a separate connector for each in-/outputting signal -(Com), signal +100%, signal + 50% and signal +25% is available. The 2-pin connectors allow the signal to be daisy-chained to the next loudspeaker easily.

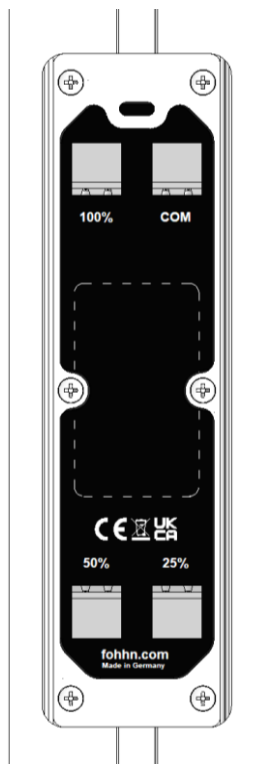

Picture 1: Terminal

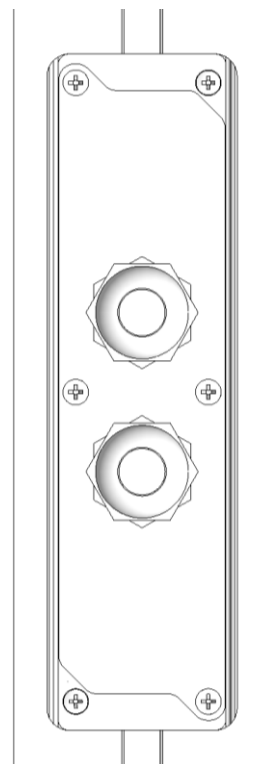

Picture 2: Terminal with cover

A terminal cover is supplied at delivery with each loudspeaker, along with two M16 cable glands. Once cabling has been completed, this can be used to cover the connector panel and provide tension relief for the cable.

Please be aware of the fact that the specified degree of protection in accordance with IEC 60529 is only obtained by mounting the terminal cover correctly. The cable glands are suitable for use with cables of between 6 and 10 mm in diameter.

If only one cable is being used, the other cable gland should be replaced by the dummy plug that has been supplied with the loudspeaker.

3.3 Operating conditions

Please note the following:

- The recommended operating temperature range for this system is -25°C to +70°C. If used in temperatures below 0°C, the system should be permanently operated using a pilot tone in order to prevent the system from freezing and getting stuck.
- Always allow the system to acclimatise before using it.
- Do not subject the system to aggressive chemical liquids or vapours.
- Always ensure that heat can be dissipated over the external surfaces of the housing.
- The system should be well ventilated at all times. To ensure sufficient airflow, it should not be covered with towels. Heat from the sun and strong lighting should also be avoided.
- Do not subject this system to strong vibrations!

3.4 Transportation and storage

Please note the following:

- This system should only be transported in its original packaging.
- Store it in a dry place with an even temperature, so that it is not affected by condensation.
- The recommended temperature range for storing this system is -10°C to +70°C.

3.5 Maintenance

Clean the system as required using a damp cloth. Do not use any cleaning products that contain aggressive chemicals.

3.6 Servicing and Repair

Servicing and/or repairs should only be carried out by qualified personnel who have been trained by Fohhn.

Do not carry out any servicing or repair on a system other than stated above.

To find a Fohhn Service centre in your area, please contact us at the address on the back page of this manual.

Keep the packaging that has been supplied with this system so that, in the event of any damage, it can be returned in its original packaging. This will reduce the risk of any further damage occurring during transportation.

4. Technical data

Fohhn Linea LEN (b) Passive column speakers for voice alarm systems													
Datasheet													
Model		LEN-20 (b)		LEN-60 (b)		LEN-100 (b)		LEN-150 (b)			LEN-220 (b)		
Certificates		EN 54-24 Type B											
Electroacoustical features													
Acoustic design		weatherproof passive line source speaker system, closed, passive 2-way CD crossover and filter, suppression of side lobes by Source Division Waveguides (SDW)											
Number of 4" drivers with treated cones		2		6		8		12			18		
2-way design		No		Yes		Yes		Yes			Yes		
Sensitivity 1W @ 4m acc. EN54-24 [2]		dB SPL 79		83		84		86			87		
SPLmax 100V @ 4m acc. to EN54-24 [2]		dB SPL 92		97 100		99 102		100 103 106			102 105 108		
Transformer options, power handling acc. to EN54-24 100V W		50		65 130		80 160		65 130 260			77,5 155 310		
Transformer options, power handling acc. to EN54-24 70V W		24,5		31,8 63,6		39,2 77,8		31,8 63,6 128,9			38 75,4 153,1		
Impedance 100% tap [1]		Ohms 200		154 77		125 63		154 77 38			129 65 32		
Impedance 50% tap [1]		Ohms 400		308 154		250 125		308 154 77			258 129 65		
Impedance 25% tap [1]		Ohms 800		615 308		500 250		615 308 154			516 258 129		
Nominal directivity HxV (-6dB, average@1-4kHz)		Deg 130 x 60		130 x 25		130 x 15		130 x 14			130 x 14		
Directivity horizontal (octave band) acc. to EN54-24													
500 Hz		Deg 360		360		360		360			360		
1000 Hz		Deg 190		190		190		190			190		
2000 Hz		Deg 120		120		120		120			120		
4000 Hz		Deg 95		95		95		95			95		
Directivity vertical (octave band) acc. to EN54-24													
500 Hz		Deg 360		90		55		35			25		
1000 Hz		Deg 120		40		25		20			15		
2000 Hz		Deg 60		25		15		14			14		
4000 Hz		Deg 30		13		8		8			8		
Mechanical features													
Housing		weatherproof aluminium housing, powder coated											
Mounting points		continuous T-slot at rear											
Front design		ball impact resistant steel grille, powder coated backed by acoustically transparent 3D mesh											
Protection class acc. to IEC529/EN60529		IP54											
Terminal		terminal connectors capable of receiving up to 2,5 mm ² , two per pin, terminal cover with dual cable gland for up to 10 mm cable diameter											
Weight kg		3		7 7,5		9,5 10		13 13,5 15			18,5 19 20,5		
Width mm		133		133		133		133			133		
Depth mm		128		128		128		128			128		
Height mm		230		640		990		1460			2200		
Standard colours		black (RAL 9005) or white (RAL 9016)											
Optional features													
Custom colours		all RAL Classic colours											
Weather protection		weatherproof without further protection as standard											
CAAD Simulation data		EASE											
All measurements normalized to freefield full-space conditions													
[1] impedance measured at a voltage producing 1W per speaker system													
[2] measured in far field of the speaker, calculated to 4m distance													

4.1 Measuring Charts

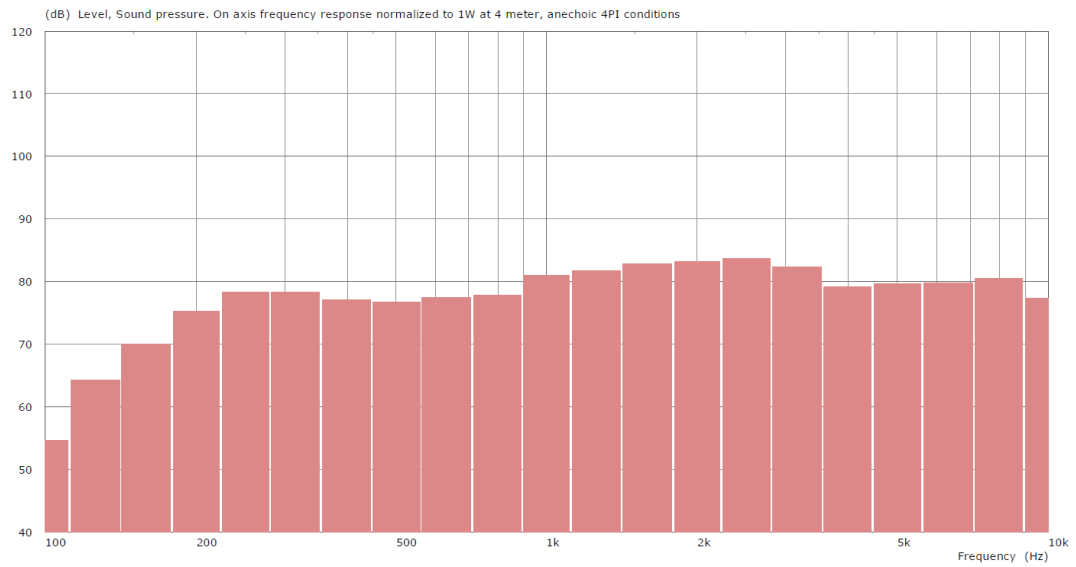

Picture 3: Frequency response LEN-20 (b)

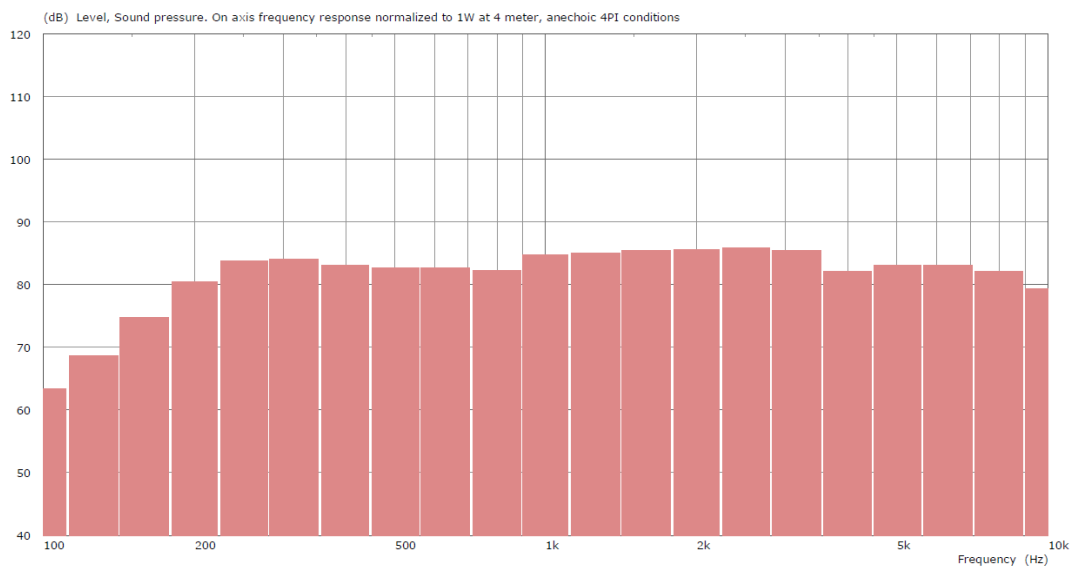

Picture 4: Frequency response LEN-60 (b)

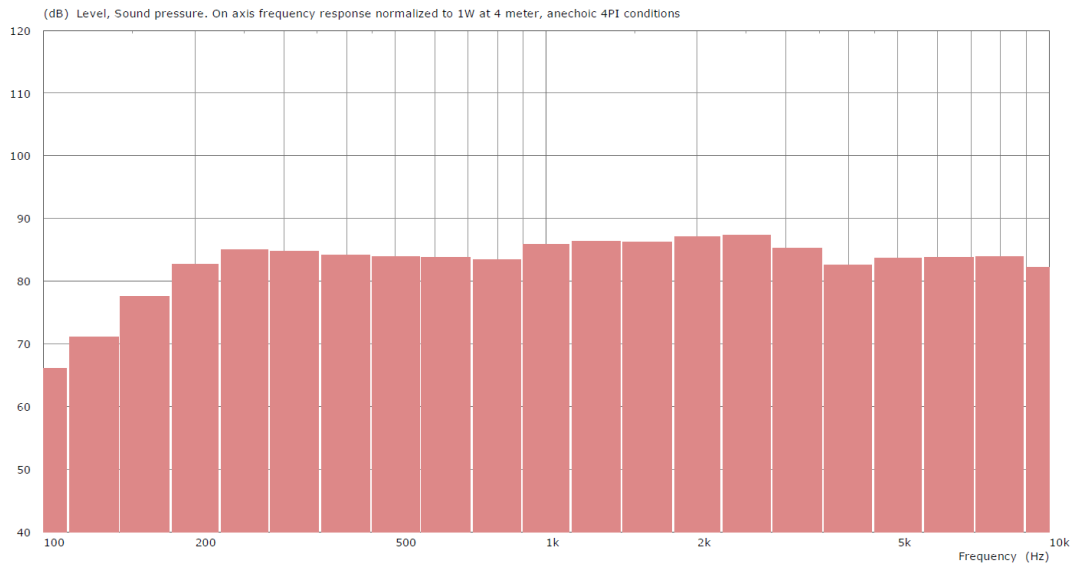

Picture 5: Frequency response LEN-100 (b)

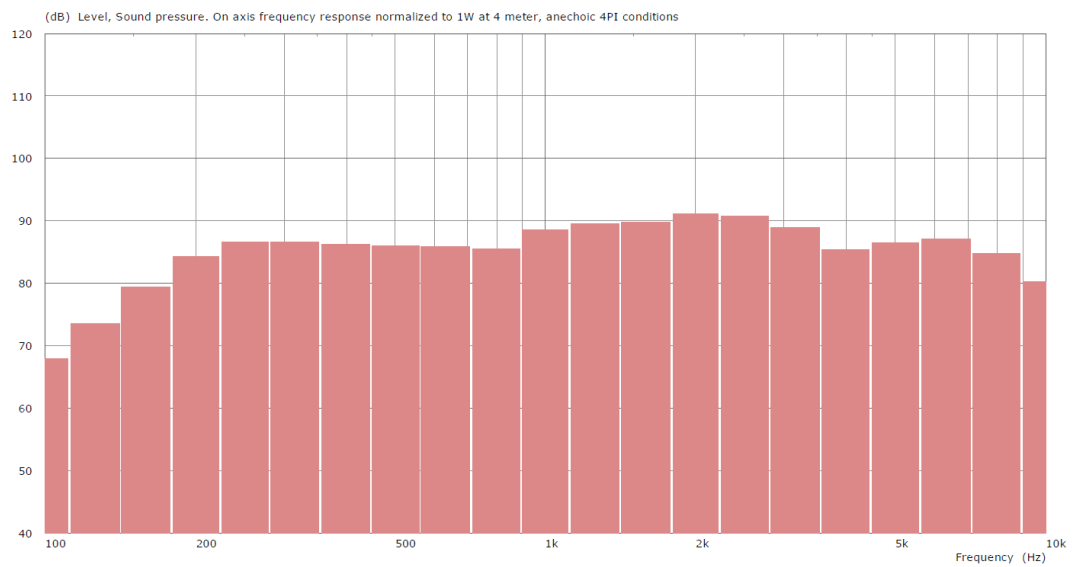

Picture 6: Frequency response LEN-150 (b)

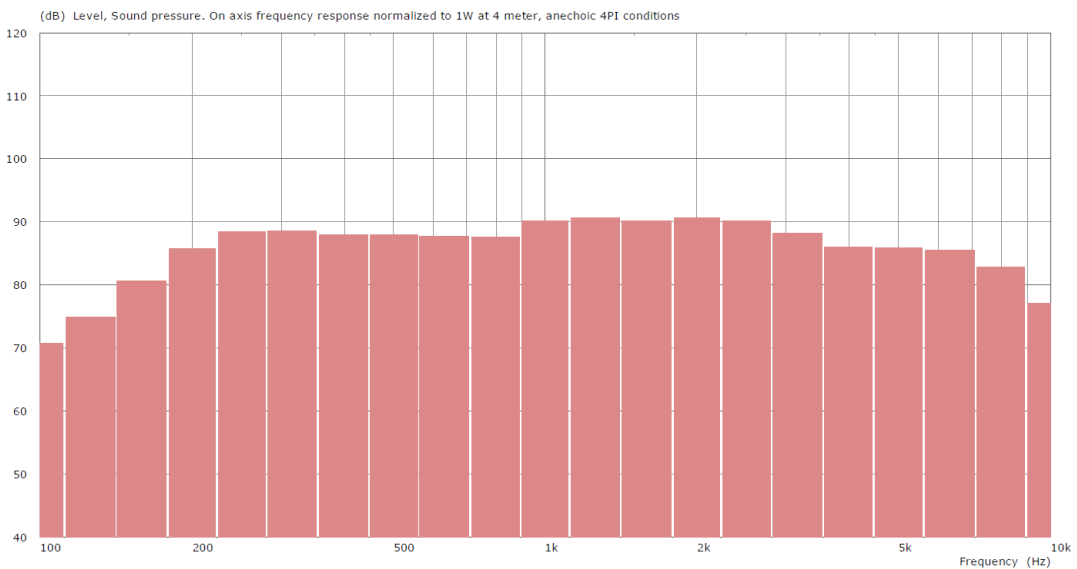

Picture 7: Frequency response LEN-220 (b)

4.2 Reference Axis Plan

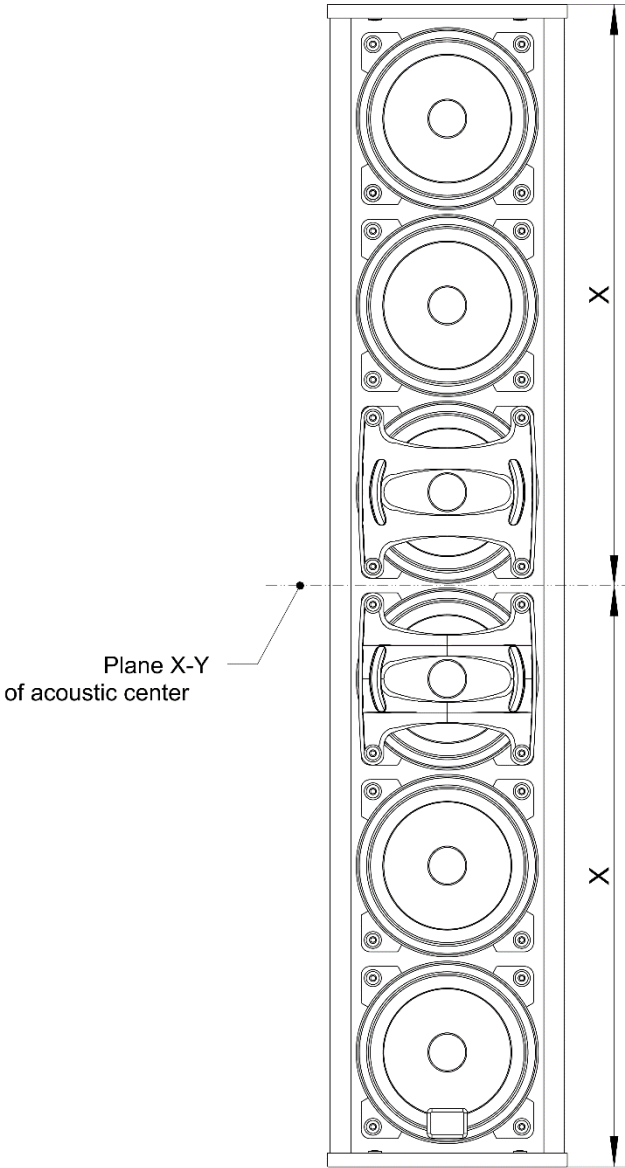

Model	X
LEN-20 (b)	116
LEN-60 (b)	320
LEN-100 (b)	495
LEN-150 (b)	732
LEN-220 (b)	1100

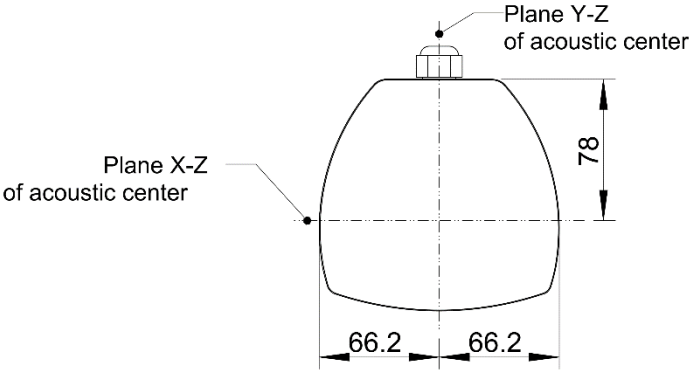

5. Accessories

WS-2

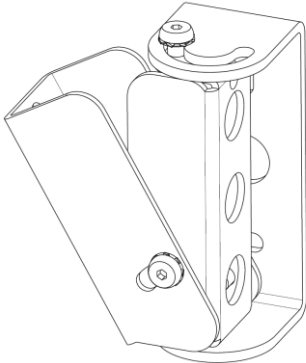

WS-4

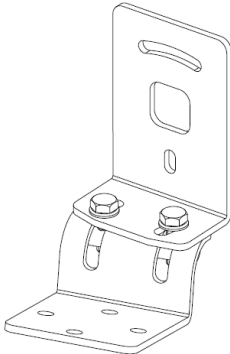

WS-5

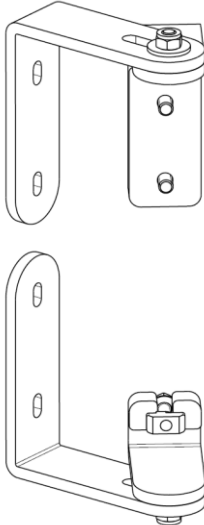

WLX-100

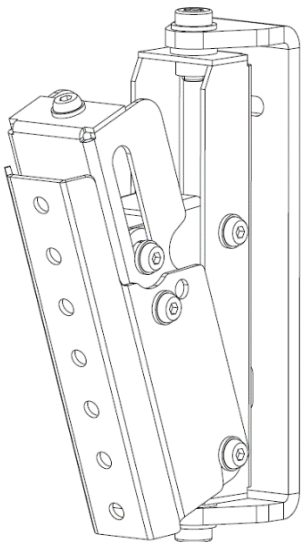

WLX-200

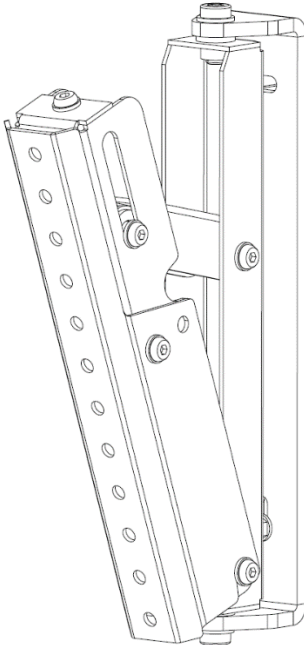

SB-S

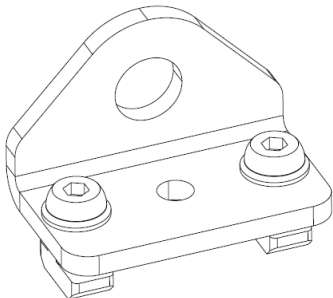

SB-L

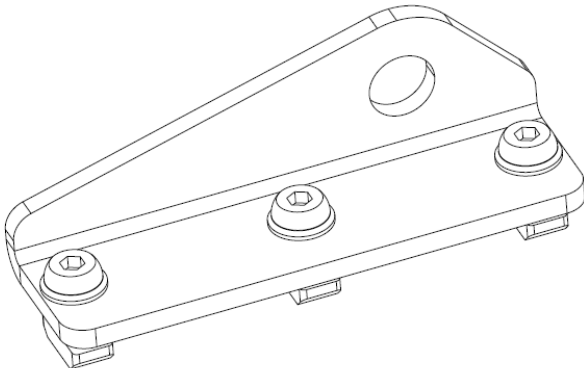

6. EG Conformity (CE marking)

Fohhn Audio AG declares that this (these) product(s) conform(s) to the essential requirements and other regulations set out in EG directives 2004/108/EG and 2006/95/EG.



Fohhn



EC-DECLARATION OF CONFORMITY

We declare that the following products:

Company	Fohhn Audio AG
Address, City	Grosser Forst 15, 72622 Nuertingen
Country	Germany
Fax number	+49 7022 93324-0

Product description	loudspeakers for voice alarm systems in fire detection and fire alarm systems in buildings, passive loudspeakers with passive crossover
Manufacturer	Fohhn Audio AG
Brand	Fohhn
Types	LEN-20 (b), LEN-60 (b), LEN-100 (b), LEN-150 (b), LEN-220 (b)

have been constructed and manufactured according to the regulations of the European directive 2014/35/EU. The following standard has been applied:

Standards	Date of version
EN 62368-1	2016-05

The products listed above are certified according to:

EN 54-24 Components of voice alarm systems - Loudspeakers	
Certificate number	1438-CPR-0409
Certification year	16
Standard	EN 54-24: 2008-06
Loudspeaker type	Type B (outdoor application)

Concerning hazardous materials please refer to our **RoHS** and **REACH** declarations.

City	Nuertingen
Date	01.04.2023
Signature	
Name, position	Jochen Schwarz, CEO

7. Declaration of Performance

Wykaz zasadniczych charakterystyk wyrobu budowlanego wg EN 54-24 List of essential characteristics of construction product according to EN 54-24

Europejska norma zharmonizowana: <i>European harmonized standard:</i>		EN 54-24:2008 Fire detection and fire alarm systems - Part 24: Components of voice alarm systems - Loudspeakers Systemy sygnalizacji pożarowej - Część 24: Dźwiękowe systemy ostrzegawcze - Głośniki	
Nazwa wyrobu budowlanego: <i>Name of construction product:</i>		LEN-Series: LEN-20 (b), LEN-60 (b), LEN-100 (b), LEN-150 (b), LEN-220 (b)	
Deklarowane zamierzone zastosowanie wyrobu zgodnie z normą zharmonizowaną*: <i>Declared intended use of product in accordance with harmonised standard*:</i>		Passive voice alarm column speakers for indoor and outdoor use	
Lp. No.	Zasadnicze charakterystyki wyrobu <i>Essential characteristics of the product</i>	Norma zharmonizowana / <i>Harmonised standard</i>	Zakres zasadniczych charakterystyk dotyczących zamierzonego zastosowania wyrobu (wstawić „+” lub „NPD” lub „ND”)** <i>Scope of essential characteristics regarding intended use of product (place „+” or „NPD” or “NA”)**</i>
		EN 54-24:2008	
Skuteczność w warunkach pożaru			
1	Granice charakterystyki częstotliwościowej / <i>Frequency response limits</i>	4.2	+
2	Odtwarzalność / <i>Reproducibility</i>	5.2	+
3	Impedancja znamionowa / <i>Rated impedance</i>	5.3	+
4	Poziome i pionowe kąty pokrycia / <i>Horizontal and vertical coverage angles</i>	5.4	+
5	Maksymalny poziom ciśnienia akustycznego / <i>Maximum sound pressure level</i>	5.5	+
Niezawodność działania			
6	Trwałość / <i>Durability</i>	4.3	+
7	Konstrukcja / <i>Construction</i>	4.4	+
8	Znakowanie i dane / <i>Marking and data</i>	4.5	+
9	Moc znamionowa (trwałość) / <i>Rated noise power (durability)</i>	5.6	+
10	Ochrona obudowy / <i>Enclosure protection</i>	5.18	+
Trwałość niezawodności działania: odporność na działanie ciepła			
11	Sucho gorąco (odporność) / <i>Dry heat (operational)</i>	5.7	+
12	Sucho gorąco (wytrzymałość) / <i>Dry heat (endurance)</i>	5.8	+
13	Zimno (odporność) / <i>Cold (operational)</i>	5.9	+
Trwałość niezawodności działania: odporność na wilgoć			
14	Wilgotne gorąco cykliczne (odporność) / <i>Damp heat, cyclic (operational)</i>	5.10	+
15	Wilgotne gorąco stałe (wytrzymałość) / <i>Damp heat, steady state (endurance)</i>	5.11	+
16	Wilgotne gorąco cykliczne (wytrzymałość) / <i>Damp heat, cyclic (endurance)</i>	5.12	+
Trwałość niezawodności działania: odporność na korozję			
17	Korozja w dwutlenku siarki SO ₂ (wytrzymałość) / <i>Sulphur dioxide corrosion (endurance)</i>	5.13	+
Trwałość niezawodności działania: odporność na udary i wibracje			
18	Udary (odporność) / <i>Shock (operational)</i>	5.14	+
19	Uderzenie (odporność) / <i>Impact (operational)</i>	5.15	+
20	Wibracje sinusoidalne (odporność) / <i>Vibration, sinusoidal (operational)</i>	5.16	+
21	Wibracje sinusoidalne (wytrzymałość) / <i>Vibration, sinusoidal (endurance)</i>	5.17	+

* Należy precyzyjnie określić zamierzone zastosowanie lub zastosowania wyrobu budowlanego z uwzględnieniem wymogów w miejscu, gdzie producent zamierza udostępnić wyrób na rynku.
The intended use or uses of the construction product should be precisely specified, taking into account the requirements in the place where the manufacturer intends to make the product available on the market.

** Znakiem „+” należy oznaczyć zasadnicze charakterystyki, których ustalenie ma być przeprowadzone przez CNBOP-PIB. W przeciwnym przypadku należy wpisać „NPD” (tj. właściwości użytkowe nieustalone, ang. *No Performance Determined*).

Essential characteristics to be determined by CNBOP-PIB, should be marked with “+”, in other case place “NPD” (No Performance Determined).

UWAGA: W przypadku komponentów, wobec których wymagania nie ma zastosowania, proszę zaznaczyć „ND” (nie dotyczy).

NOTE: For components where this requirement does not apply, please indicate “NA” (not applicable).

03.02.2023
data / date

Prezes / Dyrektor
czytelne imię i nazwisko, podpis
President / Director
Legibly name, surname, signature

 Fohhn Audio AG
Großer Forst 15
72622 Nürtingen
Deutschland
Tel.: +49 7022 93323-0
Fax: +49 7022 93324-0
E-Mail: info@fohhn.com

8. WEEE Directives (Disposal)

Electrical and electronic components must not be disposed of in standard household waste. For this reason we include the dustbin symbol shown here on our products and in manuals.

Please consult your dealer or distributor regarding product disposal in your particular country.



9. Certificates

All LINEA LEN series systems are voice alarm loudspeakers for fire detection and fire alarm systems for buildings. They are certified according to EN 54-24 Type B.

1438-CPR-0494

16

EN 54-24: 2008

Please find the complete certificate in the appendix of this manual.

10. Appendix



JEDNOSTKA NOTYFIKOWANA / NOTIFIED BODY 1438

Centrum Naukowo-Badawcze Ochrony Przeciwpowarowej

im. Józefa Tuliszkowskiego

Państwowy Instytut Badawczy

ul. Nadwiślańska 213, 05-420 Józefów

Polska / Poland



CERTYFIKAT STAŁOŚCI WŁAŚCIWOŚCI UŻYTKOWYCH CERTIFICATE OF CONSTANCY OF PERFORMANCE

1438-CPR-0494

Zgodnie z Rozporządzeniem Parlamentu Europejskiego i Rady (UE) 305/2011 z dnia 9 marca 2011 r. (Rozporządzenie CPR), niniejszy certyfikat odnosi się do wyrobu budowlanego:

Głośnik do dźwiękowych systemów ostrzegawczych typu LEN-20 T, LEN-20 (b), LEN-60 T, LEN-60 (b), LEN-100 T, LEN-100 (b), LEN-150 T, LEN-150 (b), LEN-220 T, LEN-220 (b)

<Opis wyrobu, zamierzone zastosowanie, właściwości użytkowe patrz kolejne strony certyfikatu>
wprowadzanego do obrotu pod nazwą handlową lub znakiem firmowym producenta:

In compliance with Regulation 305/2011/EU of the European Parliament and of the Council of 9 March 2011 (the Construction Products Regulation or CPR), this certificate applies to the construction product:

Loudspeaker for voice alarm systems type
LEN-20 T, LEN-20 (b), LEN-60 T, LEN-60 (b), LEN-100 T,
LEN-100 (b), LEN-150 T, LEN-150 (b), LEN-220 T, LEN-220 (b)

<Product description, intended use, performances see the following pages of the certificate>
placed on the market under the name or trade mark of:

Fohhn Audio AG
Großer Forst 15

72622 Nürtingen, Federal Republic of Germany

i wytwarzanego w zakładzie produkcyjnym:

and produced in the manufacturing plant:

Fohhn Audio AG
Großer Forst 15

72622 Nürtingen, Federal Republic of Germany

Niniejszy certyfikat potwierdza, że wszystkie postanowienia dotyczące oceny i weryfikacji stałości właściwości użytkowych określone w załączniku ZA normy:

This certificate attests that all provisions concerning the assessment and verification of constancy of performance described in Annex ZA of the standard:

EN 54-24:2008 Fire detection and fire alarm systems

Part 24: Components of voice alarm systems - Loudspeakers

w ramach systemu 1 w odniesieniu do właściwości użytkowych określonych w niniejszym certyfikacie są stosowane oraz że producent wdrożył zakładową kontrolę produkcji, która jest oceniana w celu zapewnienia stałości właściwości użytkowych wyrobu budowlanego.

under system 1 for the performance in relation to the performance set out in this certificate are applied and that the factory production control conducted by the manufacturer is assessed to ensure the constancy of performance of the construction product.

Niniejszy certyfikat został wydany po raz pierwszy w dniu **29.11.2016** r. i pozostaje ważny, zgodnie z umową nr **70/DC/CPR/2016**, do dnia **28.11.2026** r. dopóki nie zmieni się norma zharmonizowana, sam wyrób budowlany, metody OiW SWU i warunki jego wytwarzania nie ulegną istotnej zmianie oraz pod warunkiem, że nie zostanie zawieszony, cofnięty lub nie nastąpi zakończenie certyfikacji przez notyfikowaną jednostkę certyfikującą wyrób.

This certificate was first issued on **November 29, 2016** and will remain valid, in accordance with the agreement no **70/DC/CPR/2016**, until **November 28, 2026** as long as neither the harmonised standard, the construction product, the AVCP methods nor the manufacturing conditions in the plant are modified significantly, unless suspended, withdrawn or terminated by the notified product certification body.

Nr wydania certyfikatu:
Certificate issue no:

4

Data wydania:
Issue date:

24.08.2023



DYREKTOR CNBOP-PIB
DIRECTOR of CNBOP-PIB

st. bryg. dr inż. Paweł Janik



JEDNOSTKA NOTYFIKOWANA / NOTIFIED BODY 1438

Centrum Naukowo-Badawcze Ochrony Przeciwpożarowej

im. Józefa Tułszkowskiego

Państwowy Instytut Badawczy

ul. Nadwiślańska 213, 05-420 Józefów

Polska / Poland



CERTYFIKAT STAŁOŚCI WŁAŚCIWOŚCI UŻYTKOWYCH CERTIFICATE OF CONSTANCY OF PERFORMANCE

1438-CPR-0494

Nazwa wyrobu budowlanego: Name of construction product:	Głośnik do dźwiękowych systemów ostrzegawczych typu LEN-20 T, LEN-20 (b), LEN-60 T, LEN-60 (b), LEN-100 T, LEN-100 (b), LEN-150 T, LEN-150 (b), LEN-220 T, LEN-220 (b) Loudspeaker for voice alarm systems type LEN-20 T, LEN-20 (b), LEN-60 T, LEN-60 (b), LEN-100 T, LEN-100 (b), LEN-150 T, LEN-150 (b), LEN-220 T, LEN-220 (b)
Deklarowane zamierzone zastosowanie: Declared performance:	Bezpieczeństwo pożarowe Fire safety
Europejska norma zharmonizowana: European harmonised standard:	EN 54-24:2008 Fire detection and fire alarm systems Part 24: Components of voice alarm systems - Loudspeakers

Opis wyrobu / Product description

	LEN-20T	LEN-20 (b)
Typ głośnika: <i>Loudspeaker type:</i>		
Typ transformatora: <i>Transformer type:</i>	TI-140443 Rev D	
Napięcie zasilania głośnika [V]: <i>Loudspeaker power voltage [V]:</i>	100	
Moc znamionowa głośnika [W]: <i>Loudspeaker rated power [W]:</i>	50	
Ustawienia mocy głośnika na odczepach transformatora [W]: <i>Loudspeaker output setting on the transformer taps [W]:</i>	50 / 25 / 12,5	
Impedancja głośnika [Ω]: <i>Loudspeaker impedance [Ω]:</i>	16	
Impedancja transformatora - dla poszczególnych odczepów [Ω]: <i>Impedance of transformer - for particular terminals [Ω]:</i>	200 / 400 / 800	
Maksymalny poziom ciśnienia akustycznego (moc znamionowa / 4m) [dB]: <i>Maximum sound pressure level (rated power / 4m) [dB]:</i>	92	
Czułość S (1W / 4m) [dB]: <i>Sensitivity S (1W / 4m) [dB]:</i>	78	
Kąt promieniowania dla 500 Hz [°]: <i>Coverage angle for 500 Hz [°]:</i>	360	
Kąt promieniowania dla 1 kHz [°]: <i>Coverage angle for 1kHz [°]:</i>	poziomo / horizontal - 190 pionowo / vertical - 120	
Kąt promieniowania dla 2 kHz [°]: <i>Coverage angle for 2kHz [°]:</i>	poziomo / horizontal - 120 pionowo / vertical - 60	
Kąt promieniowania dla 4 kHz [°]: <i>Coverage angle for 4kHz [°]:</i>	poziomo / horizontal - 95 pionowo / vertical - 30	
Rodzaj środowiska pracy: <i>Type of work environment:</i>	B	
Stopień ochrony IP: <i>IP protection:</i>	33 C	
Zaciski: <i>Terminals:</i>	2 ceramiczne lub plastikowe kostki przyłączeniowe 2 ceramic or plastic material connection blocks	4 ceramiczne lub plastikowe kostki przyłączeniowe 4 ceramic or plastic material connection blocks
Sposób zamocowania: <i>Type of installation:</i>	natynkowy montaż do ściany surface wall mounted	
Wymiary głośnika z obudową [mm]: <i>Dimensions of loudspeaker with housing [mm]:</i>	230 x 130 x 120	
Materiał obudowy: <i>Material of housing:</i>	metal	
Masa [g]: <i>Mass [g]:</i>	3100	
Elementy opcjonalne / Optional elements		
Informacja identyfikująca / Identifying data		
Parametr zadziałania bezpiecznika: <i>Fuse activation parameter:</i>	nie dotyczy not applicable	
Rodzaj i typ kondensatora: <i>Type of capacitor:</i>	nie dotyczy not applicable	
Filtr: <i>Filter:</i>	nie dotyczy not applicable	
Typ dodatkowego zabezpieczenia: <i>Type of additional protection:</i>	nie dotyczy not applicable	

Nr wydania certyfikatu: 4
Certificate issue no:

Data wydania: 24.08.2023
Issue date:

DC/CPR-13/12.09.2016



DYREKTOR CNBOP-PIB
DIRECTOR of CNBOP-PIB

Paweł Janik
st. bryg. dr inż. Paweł Janik

Strona / Page 2 / 7



JEDNOSTKA NOTYFIKOWANA / NOTIFIED BODY 1438

Centrum Naukowo-Badawcze Ochrony Przeciwpożarowej

im. Józefa Tułuskowskiego

Państwowy Instytut Badawczy

ul. Nadwiślańska 213, 05-420 Józefów

Polska / Poland



CERTYFIKAT STAŁOŚCI WŁAŚCIWOŚCI UŻYTKOWYCH
CERTIFICATE OF CONSTANCY OF PERFORMANCE

1438-CPR-0494

Nazwa wyrobu budowlanego: <i>Name of construction product:</i>	Głośnik do dźwiękowych systemów ostrzegawczych typu LEN-20 T, LEN-20 (b), LEN-60 T, LEN-60 (b), LEN-100 T, LEN-100 (b), LEN-150 T, LEN-150 (b), LEN-220 T, LEN-220 (b) Loudspeaker for voice alarm systems type LEN-20 T, LEN-20 (b), LEN-60 T, LEN-60 (b), LEN-100 T, LEN-100 (b), LEN-150 T, LEN-150 (b), LEN-220 T, LEN-220 (b)
Deklarowane zamierzone zastosowanie: <i>Declared performance:</i>	Bezpieczeństwo pożarowe Fire safety
Europejska norma zharmonizowana: <i>European harmonised standard:</i>	EN 54-24:2008 Fire detection and fire alarm systems Part 24: Components of voice alarm systems - Loudspeakers

Opis wyrobu / Product description

	LEN-60T	LEN-60T (b)
Typ głośnika: <i>Loudspeaker type:</i>	LEN-60T	
Typ transformatora: <i>Transformer type:</i>	T1-140443 Rev. D	
Napięcie zasilania głośnika [V]: <i>Loudspeaker power voltage [V]:</i>	100	
Moc znamionowa głośnika [W]: <i>Loudspeaker rated power [W]:</i>	65	130
Ustawienia mocy głośnika na odczepach transformatora [W]: <i>Loudspeaker output setting on the transformer taps [W]:</i>	65 / 32.5 / 16.3	130 / 65 / 32.5
Impedancja głośnika [Ω]: <i>Loudspeaker impedance [Ω]:</i>	16	
Impedancja transformatora - dla poszczególnych odczepów [Ω]: <i>Impedance of transformer - for particular terminals [Ω]:</i>	154 / 308 / 615	77 / 154 / 308
Maksymalny poziom ciśnienia akustycznego (moc znamionowa / 4m) [dB]: <i>Maximum sound pressure level (rated power / 4m) [dB]:</i>	97	100
Czułość S (1W / 4m) [dB]: <i>Sensitivity S (1W / 4m) [dB]:</i>	82	
Kąt promieniowania dla 500 Hz [°]: <i>Coverage angle for 500 Hz [°]:</i>	poziomo / horizontal - 360 pionowo / vertical - 90	
Kąt promieniowania dla 1 kHz [°]: <i>Coverage angle for 1kHz [°]:</i>	poziomo / horizontal - 190 pionowo / vertical - 40	
Kąt promieniowania dla 2 kHz [°]: <i>Coverage angle for 2kHz [°]:</i>	poziomo / horizontal - 120 pionowo / vertical - 25	
Kąt promieniowania dla 4 kHz [°]: <i>Coverage angle for 4kHz [°]:</i>	poziomo / horizontal - 95 pionowo / vertical - 13	
Rodzaj środowiska pracy: <i>Type of work environment:</i>	B	
Stopień ochrony IP: <i>IP protection:</i>	33 C	
Zaciski: <i>Terminals:</i>	2 ceramiczne lub plastikowe kostki przyłączeniowe 2 ceramic or plastic material connection blocks	4 ceramiczne lub plastikowe kostki przyłączeniowe 4 ceramic or plastic material connection blocks
Sposób zamocowania: <i>Type of installation:</i>	natynkowy montaż do ściany surface wall mounted	
Wymiary głośnika z obudową [mm]: <i>Dimensions of loudspeaker with housing [mm]:</i>	640 x 130 x 120	
Material obudowy: <i>Material of housing:</i>	metal	
Masa [g]: <i>Mass [g]:</i>	6500	7600
Elementy opcjonalne / Optional elements		
Informacja identyfikująca / Identifying data		
Parametr zadziałania bezpiecznika: <i>Fuse activation parameter:</i>	nie dotyczy not applicable	
Rodzaj i typ kondensatora: <i>Type of capacitor:</i>	nie dotyczy not applicable	
Filtr: <i>Filter:</i>	nie dotyczy not applicable	
Typ dodatkowego zabezpieczenia: <i>Type of additional protection:</i>	nie dotyczy not applicable	

Nr wydania certyfikatu: 4
Certificate issue no:

Data wydania: 24.08.2023
Issue date:



DYREKTOR CNBOP-PIB
DIRECTOR of CNBOP-PIB

Janik
st. bryg. dr inż. Paweł Janik



JEDNOSTKA NOTYFIKOWANA / NOTIFIED BODY 1438

Centrum Naukowo-Badawcze Ochrony Przeciwpożarowej

im. Józefa Tułuskowskiego

Państwowy Instytut Badawczy

ul. Nadwiślańska 213, 05-420 Józefów

Polska / Poland



CERTYFIKAT STAŁOŚCI WŁAŚCIWOŚCI UŻYTKOWYCH CERTIFICATE OF CONSTANCY OF PERFORMANCE

1438-CPR-0494

Nazwa wyrobu budowlanego: Name of construction product:	Głośnik do dźwiękowych systemów ostrzegawczych typu LEN-20 T, LEN-20 (b), LEN-60 T, LEN-60 (b), LEN-100 T, LEN-100 (b), LEN-150 T, LEN-150 (b), LEN-220 T, LEN-220 (b) Loudspeaker for voice alarm systems type LEN-20 T, LEN-20 (b), LEN-60 T, LEN-60 (b), LEN-100 T, LEN-100 (b), LEN-150 T, LEN-150 (b), LEN-220 T, LEN-220 (b)
Deklarowane zamierzone zastosowanie: Declared performance:	Bezpieczeństwo pożarowe Fire safety
Europejska norma zharmonizowana: European harmonised standard:	EN 54-24:2008 Fire detection and fire alarm systems Part 24: Components of voice alarm systems - Loudspeakers

Opis wyrobu / Product description

	LEN-100T	LEN-100T (b)
Typ głośnika: Loudspeaker type:	LEN-100T	
Typ transformatora: Transformer type:	TI-140443 Rev. D	
Napięcie zasilania głośnika [V]: Loudspeaker power voltage [V]:	100	
Moc znamionowa głośnika [W]: Loudspeaker rated power [W]:	80	160
Ustawienia mocy głośnika na odczepach transformatora [W]: Loudspeaker output setting on the transformer taps [W]:	80 / 40 / 20	160 / 80 / 40
Impedancja głośnika [Ω]: Loudspeaker impedance [Ω]:	16	
Impedancja transformatora - dla poszczególnych odczepów [Ω]: Impedance of transformer - for particular terminals [Ω]:	125 / 250 / 500	63 / 125 / 250
Maksymalny poziom ciśnienia akustycznego (moc znamionowa / 4m) [dB]: Maximum sound pressure level (rated power / 4m) [dB]:	99	102
Czułość S (1W / 4m) [dB]: Sensitivity S (1W / 4m) [dB]:	83	
Kąt promieniowania dla 500 Hz [°]: Coverage angle for 500 Hz [°]:	poziomo / horizontal - 360 poziomo / horizontal - 55	
Kąt promieniowania dla 1 kHz [°]: Coverage angle for 1kHz [°]:	poziomo / horizontal - 190 poziomo / horizontal - 25	
Kąt promieniowania dla 2 kHz [°]: Coverage angle for 2kHz [°]:	poziomo / horizontal - 120 poziomo / horizontal - 15	
Kąt promieniowania dla 4 kHz [°]: Coverage angle for 4kHz [°]:	poziomo / horizontal - 95 poziomo / horizontal - 8	
Rodzaj środowiska pracy: Type of work environment:	B	
Stopień ochrony IP: IP protection:	33 C	
Zaciski: Terminals:	2 ceramiczne lub plastikowe kostki przyłączeniowe 2 ceramic or plastic material connection blocks	4 ceramiczne lub plastikowe kostki przyłączeniowe 4 ceramic or plastic material connection blocks
Sposób zamocowania: Type of installation:	natynkowy montaż do ściany surface wall mounted	
Wymiary głośnika z obudową [mm]: Dimensions of loudspeaker with housing [mm]:	990 x 130 x 120	
Material obudowy: Material of housing:	metal	
Masa [g]: Mass [g]:	8800	9600
Elementy opcjonalne / Optional elements		
Informacja identyfikująca / Identifying data		
Parametr zadziałania bezpiecznika: Fuse activation parameter:	nie dotyczy not applicable	
Rodzaj i typ kondensatora: Type of capacitor:	nie dotyczy not applicable	
Filtr: Filter:	nie dotyczy not applicable	
Typ dodatkowego zabezpieczenia: Type of additional protection:	nie dotyczy not applicable	

Nr wydania certyfikatu: 4
Certificate issue no:

Data wydania: 24.08.2023
Issue date:



DYREKTOR CNBOP-PIB
DIRECTOR of CNBOP-PIB

Janik
st. brg. dr inż. Paweł Janik



JEDNOSTKA NOTYFIKOWANA / NOTIFIED BODY 1438

Centrum Naukowo-Badawcze Ochrony Przeciwpożarowej

im. Józefa Tułuszkowskiego

Państwowy Instytut Badawczy

ul. Nadwiślańska 213, 05-420 Józefów

Polska / Poland



CERTYFIKAT STAŁOŚCI WŁAŚCIWOŚCI UŻYTKOWYCH
CERTIFICATE OF CONSTANCY OF PERFORMANCE

1438-CPR-0494

Nazwa wyrobu budowlanego: <i>Name of construction product:</i>	Głośnik do dźwiękowych systemów ostrzegawczych typu LEN-20 T, LEN-20 (b), LEN-60 T, LEN-60 (b), LEN-100 T, LEN-100 (b), LEN-150 T, LEN-150 (b), LEN-220 T, LEN-220 (b) Loudspeaker for voice alarm systems type LEN-20 T, LEN-20 (b), LEN-60 T, LEN-60 (b), LEN-100 T, LEN-100 (b), LEN-150 T, LEN-150 (b), LEN-220 T, LEN-220 (b)
Deklarowane zamierzone zastosowanie: <i>Declared performance:</i>	Bezpieczeństwo pożarowe Fire safety
Europejska norma zharmonizowana: <i>European harmonised standard:</i>	EN 54-24:2008 Fire detection and fire alarm systems Part 24: Components of voice alarm systems - Loudspeakers

Opis wyrobu / Product description

	LEN-150T	LEN-150T (b)	
Typ głośnika: <i>Loudspeaker type:</i>	LEN-150T		
Typ transformatora: <i>Transformer type:</i>	TI-140443 Rev. D		
Napięcie zasilania głośnika [V]: <i>Loudspeaker power voltage [V]:</i>	100		
Moc znamionowa głośnika [W]: <i>Loudspeaker rated power [W]:</i>	65	130	260
Ustawienia mocy głośnika na odczepach transformatora [W]: <i>Loudspeaker output setting on the transformer taps [W]:</i>	65 / 32,5 / 16,3	130 / 65 / 32,5	260 / 130 / 65
Impedancja głośnika [Ω]: <i>Loudspeaker impedance [Ω]:</i>	16		
Impedancja transformatora - dla poszczególnych odczepów [Ω]: <i>Impedance of transformer - for particular terminals [Ω]:</i>	154 / 308 / 615	77 / 154 / 308	38 / 77 / 154
Maksymalny poziom ciśnienia akustycznego (moc znamionowa / 4m) [dB]: <i>Maximum sound pressure level (rated power / 4m) [dB]:</i>	100	103	106
Czułość S (1W / 4m) [dB]: <i>Sensitivity S (1W / 4m) [dB]:</i>	85		
Kąt promieniowania dla 500 Hz [°]: <i>Coverage angle for 500 Hz [°]:</i>	poziomo / horizontal - 360 poziomo / horizontal - 35		
Kąt promieniowania dla 1 kHz [°]: <i>Coverage angle for 1 kHz [°]:</i>	poziomo / horizontal - 190 poziomo / horizontal - 20		
Kąt promieniowania dla 2 kHz [°]: <i>Coverage angle for 2 kHz [°]:</i>	poziomo / horizontal - 120 poziomo / horizontal - 14		
Kąt promieniowania dla 4 kHz [°]: <i>Coverage angle for 4 kHz [°]:</i>	poziomo / horizontal - 95 poziomo / horizontal - 8		
Rodzaj środowiska pracy: <i>Type of work environment:</i>	B		
Stopień ochrony IP: <i>IP protection:</i>	33 C		
Zaciski: <i>Terminals:</i>	2 ceramiczne lub plastikowe kostki przyłączeniowe 2 ceramic or plastic material connection blocks	4 ceramiczne lub plastikowe kostki przyłączeniowe 4 ceramic or plastic material connection blocks	
Sposób zamocowania: <i>Type of installation:</i>	natynkowy montaż do ściany surface wall mounted		
Wymiary głośnika z obudową [mm]: <i>Dimensions of loudspeaker with housing [mm]:</i>	1460 x 130 x 120		
Materiał obudowy: <i>Material of housing:</i>	metal		
Masa [g]: <i>Mass [g]:</i>	12200	13000	14500
Elementy opcjonalne / Optional elements		Informacja identyfikująca / Identifying data	
Parametr zadziałania bezpiecznika: <i>Fuse activation parameter:</i>	nie dotyczy not applicable		
Rodzaj i typ kondensatora: <i>Type of capacitor:</i>	nie dotyczy not applicable		
Filtr: <i>Filter:</i>	nie dotyczy not applicable		
Typ dodatkowego zabezpieczenia: <i>Type of additional protection:</i>	nie dotyczy not applicable		

Nr wydania certyfikatu: 4
Certificate issue no:

Data wydania: 24.08.2023
Issue date:



DYREKTOR CNBOP-PIB
DIRECTOR of CNBOP-PIB

Pawel Janik
st. bryg. dr inż. Paweł Janik



JEDNOSTKA NOTYFIKOWANA / NOTIFIED BODY 1438

Centrum Naukowo-Badawcze Ochrony Przeciwpożarowej

im. Józefa Tułiszewskiego

Państwowy Instytut Badawczy

ul. Nadwiślańska 213, 05-420 Józefów

Polska / Poland



CERTYFIKAT STAŁOŚCI WŁAŚCIWOŚCI UŻYTKOWYCH CERTIFICATE OF CONSTANCY OF PERFORMANCE

1438-CPR-0494

Nazwa wyrobu budowlanego: <i>Name of construction product:</i>	Głośnik do dźwiękowych systemów ostrzegawczych typu LEN-20 T, LEN-20 (b), LEN-60 T, LEN-60 (b), LEN-100 T, LEN-100 (b), LEN-150 T, LEN-150 (b), LEN-220 T, LEN-220 (b) Loudspeaker for voice alarm systems type LEN-20 T, LEN-20 (b), LEN-60 T, LEN-60 (b), LEN-100 T, LEN-100 (b), LEN-150 T, LEN-150 (b), LEN-220 T, LEN-220 (b)
Deklarowane zamierzone zastosowanie: <i>Declared performance:</i>	Bezpieczeństwo pożarowe Fire safety
Europejska norma zharmonizowana: <i>European harmonised standard:</i>	EN 54-24:2008 Fire detection and fire alarm systems Part 24: Components of voice alarm systems - Loudspeakers

Opis wyrobu / Product description

	LEN-220T	LEN-220T (b)	
Typ głośnika: <i>Loudspeaker type:</i>	TI-140443 Rev. D		
Typ transformatora: <i>Transformer type:</i>	100		
Napięcie zasilania głośnika [V]: <i>Loudspeaker power voltage [V]:</i>	77,5	155	310
Moc znamionowa głośnika [W]: <i>Loudspeaker rated power [W]:</i>	77,5 / 38,8 / 19,4	155 / 77,5 / 38,8	310 / 155 / 77,5
Ustawienia mocy głośnika na odczepach transformatora [W]: <i>Loudspeaker output setting on the transformer taps [W]:</i>	16		
Impedancja głośnika [Ω]: <i>Loudspeaker impedance [Ω]:</i>	129 / 258 / 516	65 / 129 / 258	32 / 65 / 129
Impedancja transformatora - dla poszczególnych odczepów [Ω]: <i>Impedance of transformer - for particular terminals [Ω]:</i>	102	105	108
Maksymalny poziom ciśnienia akustycznego (moc znamionowa / 4m) [dB]: <i>Maximum sound pressure level (rated power / 4m) [dB]:</i>	86		
Czułość S (1W / 4m) [dB]: <i>Sensitivity S (1W / 4m) [dB]:</i>	poziomo / horizontal - 360 poziomo / horizontal - 25		
Kąt promieniowania dla 500 Hz [°]: <i>Coverage angle for 500 Hz [°]:</i>	poziomo / horizontal - 190 poziomo / horizontal 15		
Kąt promieniowania dla 1 kHz [°]: <i>Coverage angle for 1kHz [°]:</i>	poziomo / horizontal - 120 poziomo / horizontal 14		
Kąt promieniowania dla 2 kHz [°]: <i>Coverage angle for 2kHz [°]:</i>	poziomo / horizontal - 95 poziomo / horizontal 8		
Kąt promieniowania dla 4 kHz [°]: <i>Coverage angle for 4kHz [°]:</i>	B		
Rodzaj środowiska pracy: <i>Type of work environment:</i>	33 C		
Stopień ochrony IP: <i>IP protection:</i>	2 ceramiczne lub plastikowe kostki przyłączeniowe 2 ceramic or plastic material connection blocks	4 ceramiczne lub plastikowe kostki przyłączeniowe 4 ceramic or plastic material connection blocks	
Zaciski: <i>Terminals:</i>	natynkowy montaż do ściany surface wall mounted		
Sposób zamocowania: <i>Type of installation:</i>	2200 x 130 x 120		
Wymiary głośnika z obudową [mm]: <i>Dimensions of loudspeaker with housing [mm]:</i>	metal		
Materiał obudowy: <i>Material of housing:</i>	17000	18000	19500
Masa [g]: <i>Mass [g]:</i>	Elementy opcjonalne / Optional elements		
Parametr zadziałania bezpiecznika: <i>Fuse activation parameter:</i>	Informacja identyfikująca / Identifying data		
Rodzaj i typ kondensatora: <i>Type of capacitor:</i>	nie dotyczy not applicable		
Filter: <i>Filter:</i>	nie dotyczy not applicable		
Typ dodatkowego zabezpieczenia: <i>Type of additional protection:</i>	nie dotyczy not applicable		

Nr wydania certyfikatu: 4
Certificate issue no:

Data wydania: 24.08.2023
Issue date:



DYREKTOR CNBOP-PIB
DIRECTOR of CNBOP-PIB

Janik
st. bryg. dr inż. Paweł Janik



JEDNOSTKA NOTYFIKOWANA / NOTIFIED BODY 1438

Centrum Naukowo-Badawcze Ochrony Przeciwpożarowej

im. Józefa Tuliszkowskiego

Państwowy Instytut Badawczy

ul. Nadwiślańska 213, 05-420 Józefów

Polska / Poland



CERTYFIKAT STAŁOŚCI WŁAŚCIWOŚCI UŻYTKOWYCH CERTIFICATE OF CONSTANCY OF PERFORMANCE

1438-CPR-0494

Nazwa wyrobu budowlanego: <i>Name of construction product:</i>	Głośnik do dźwiękowych systemów ostrzegawczych typu LEN-20 T, LEN-20 (b), LEN-60 T, LEN-60 (b), LEN-100 T, LEN-100 (b), LEN-150 T, LEN-150 (b), LEN-220 T, LEN-220 (b)
Deklarowane zamierzone zastosowanie: <i>Declared performance:</i>	Bezpieczeństwo pożarowe Fire safety
Europejska norma zharmonizowana: <i>European harmonised standard:</i>	EN 54-24:2008 Fire detection and fire alarm systems Part 24: Components of voice alarm systems - Loudspeakers

Wykaz właściwości użytkowych / Table of performance

Lp. No.	Zasadnicze charakterystyki wyrobu <i>Essential characteristics of the product</i>	EN 54-24:2008	Właściwości użytkowe ^{1) 2)} <i>Performance ^{1) 2)}</i>
		Rozdział <i>Clause</i>	
Skuteczność w warunkach pożarowych / Performance under fire conditions			
1	Odpowiedź częstotliwościowa / <i>Frequency response limit</i>	4.2	spełnia / <i>pass</i>
2	Powtarzalność / <i>Reproducibility</i>	5.2	spełnia / <i>pass</i>
3	Impedancja znamionowa / <i>Rated impedance</i>	5.3	spełnia / <i>pass</i>
4	Charakterystyka kąta pozioma i pionowa / <i>Horizontal and vertical coverage angles</i>	5.4	spełnia / <i>pass</i>
5	Maksymalny poziom ciśnienia dźwięku / <i>Maximum sound pressure level</i>	5.5	spełnia / <i>pass</i>
Niezawodność działania / Operational reliability			
6	Trwałość / <i>Durability</i>	4.3	spełnia / <i>pass</i>
7	Konstrukcja / <i>Construction</i>	4.4	spełnia / <i>pass</i>
8	Znakowanie i dokumentacja techniczna / <i>Marking and data</i>	4.5	spełnia / <i>pass</i>
9	Znamionowa moc dźwięku (trwałość) / <i>Rated noise power (durability)</i>	5.6	spełnia / <i>pass</i>
10	Stopień ochrony obudowy / <i>Enclosure protection</i>	5.18	spełnia / <i>pass</i>
Trwałość niezawodności działania: odporność na działanie ciepła / Durability of operational reliability, temperature resistance			
11	Sucho gorąco (odporność) / <i>Dry heat (operational)</i>	5.7	spełnia / <i>pass</i>
12	Sucho gorąco (wytrzymałość) / <i>Dry heat (endurance)</i>	5.8	spełnia / <i>pass</i>
13	Zimno (odporność) / <i>Cold (operational)</i>	5.9	spełnia / <i>pass</i>
Trwałość niezawodności działania: odporność na wilgoć / Durability of operational reliability, humidity resistance			
14	Wilgotne gorąco cykliczne (odporność) / <i>Damp heat, cyclic (operational)</i>	5.10	spełnia / <i>pass</i>
15	Wilgotne gorąco stałe (wytrzymałość) / <i>Damp heat, steady state (endurance)</i>	5.11	spełnia / <i>pass</i>
16	Wilgotne gorąco cykliczne (wytrzymałość) / <i>Damp heat, cyclic (endurance)</i>	5.12	spełnia / <i>pass</i>
Trwałość niezawodności działania: odporność na korozję / Durability of operational reliability, corrosion resistance			
17	Korozja spowodowana dwutlenkiem siarki (wytrzymałość) / <i>Sulphur dioxide corrosion (endurance)</i>	5.13	spełnia / <i>pass</i>
Trwałość niezawodności działania: odporność na udary i wibracje / Durability of operational reliability, shock and vibration resistance			
18	Udar (odporność) / <i>Shock (operational)</i>	5.14	spełnia / <i>pass</i>
19	Uderzenie (odporność) / <i>Impact (operational)</i>	5.15	spełnia / <i>pass</i>
20	Wibracje sinusoidalne (odporność) / <i>Vibration, sinusoidal (operational)</i>	5.16	spełnia / <i>pass</i>
21	Wibracje sinusoidalne (wytrzymałość) / <i>Vibration, sinusoidal (endurance)</i>	5.17	spełnia / <i>pass</i>

¹⁾ „NPD” (tj. właściwości użytkowe nieustalone, ang. *No Performance Determined*) oznacza, że właściwości użytkowe nie zostały ustalone przez CNBOP-PIB.

„NPD” (ie. *No Performance Determined*) means that performances were not determined by CNBOP-PIB.

²⁾ Zapis „Nie dotyczy” oznacza, że zasadnicza charakterystyka nie ma zastosowania dla danego wyrobu.

“Not applicable” means that the essential characteristic does not apply to the product in question.

Nr wydania certyfikatu: 4
Certificate issue no:

Data wydania: 24.08.2023
Issue date:



DYREKTOR CNBOP-PIB
DIRECTOR of CNBOP-PIB

Janik
st. bryg. dr inż. Paweł Janik

FOHNN AUDIO AG

Großer Forst 15
72622 Nürtingen
Germany

Tel. +49 7022 93323-0

Fax +49 7022 93324-0

www.fohnn.com

info@fohnn.com

Fohhn on Social Media

